

Pivo Pod Black

Quick start guide

Table of contents

| | |
|---------------------------------|-------|
| Pod Overview | 3-4 |
| Charging the Pod | 5 |
| LED Indicator Status | 6 |
| Downloading the Pivo apps | 7 |
| Creating a Pivo Account | 8 |
| Pairing your smartphone | 9 |
| Positioning your smartphone | 10 |
| Remote Control overview | 12 |
| Notice for Australian customers | 16 |
| FCC Compliance information | 17 |
| Introduction to Pivo apps | 18-30 |
| Additional information | 31 |

Pod overview

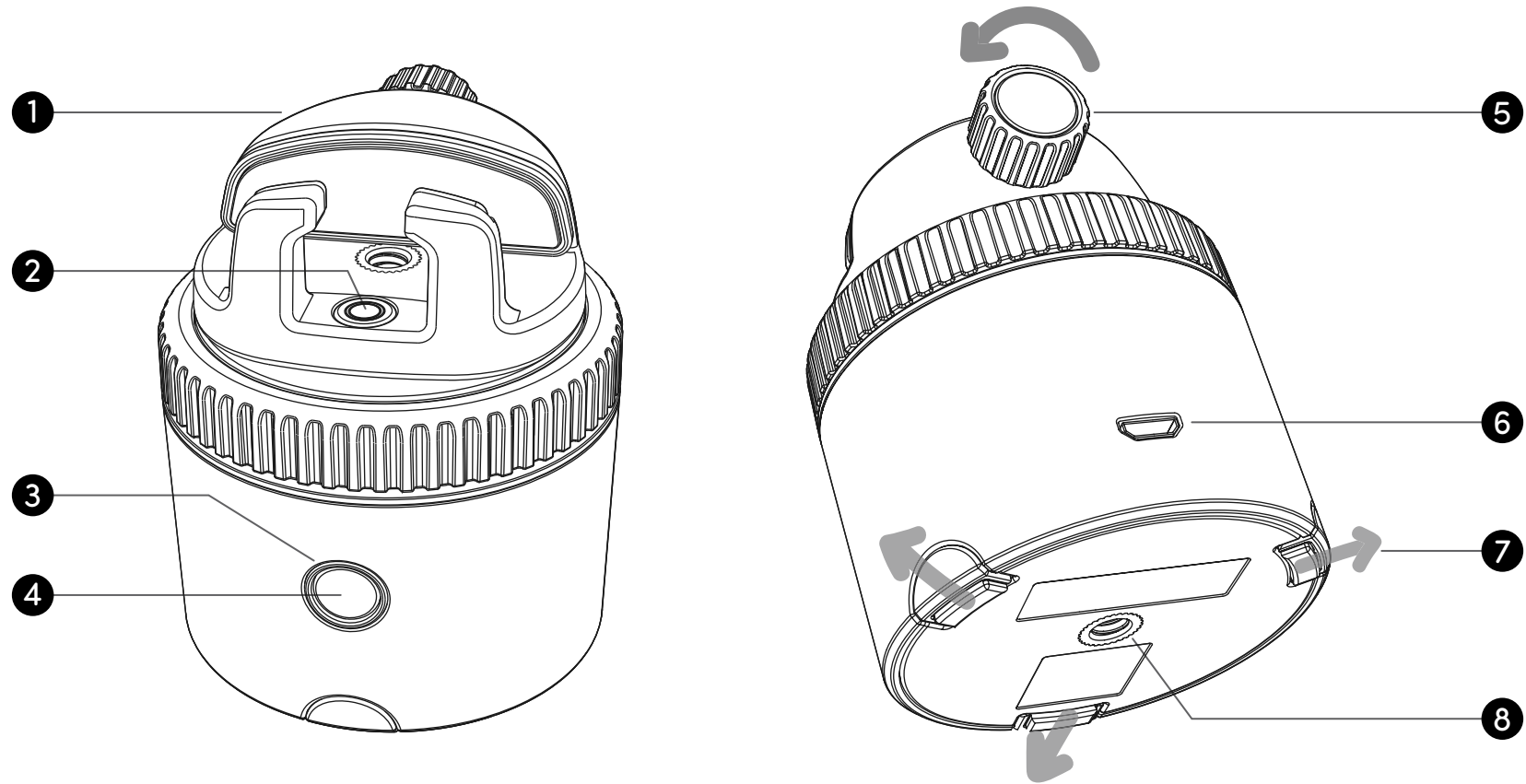

1. Panoramic Mount

2. Bubble level

3. LED indicator

4. Power button

5. Grip fastener

6. Micro USB charging port

7. Extendable legs

8. 1/4" UN thread

Pod overview

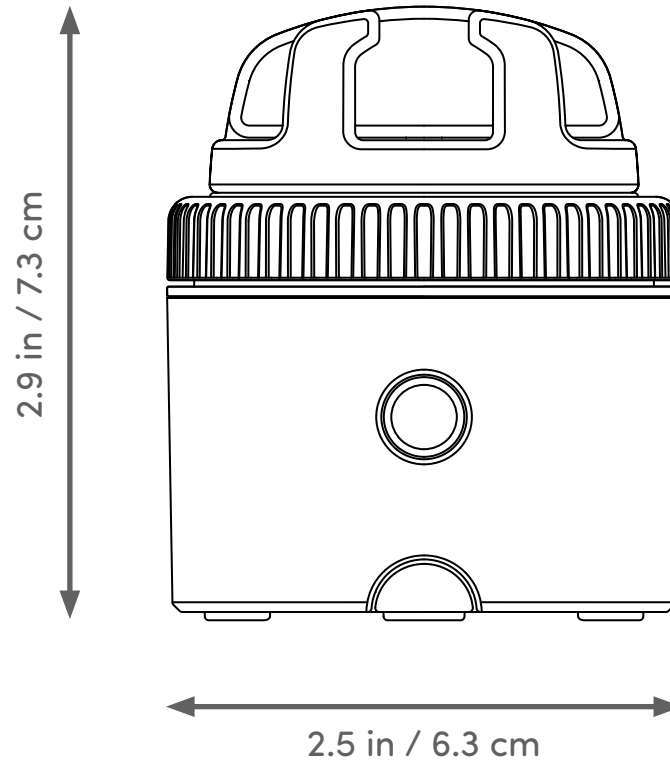

Height (without mount): 2 in. / 5 cm

Bluetooth: BLE 4.0

Maximum load: 2.2 lb / 1 kg

Battery: 500 mAh





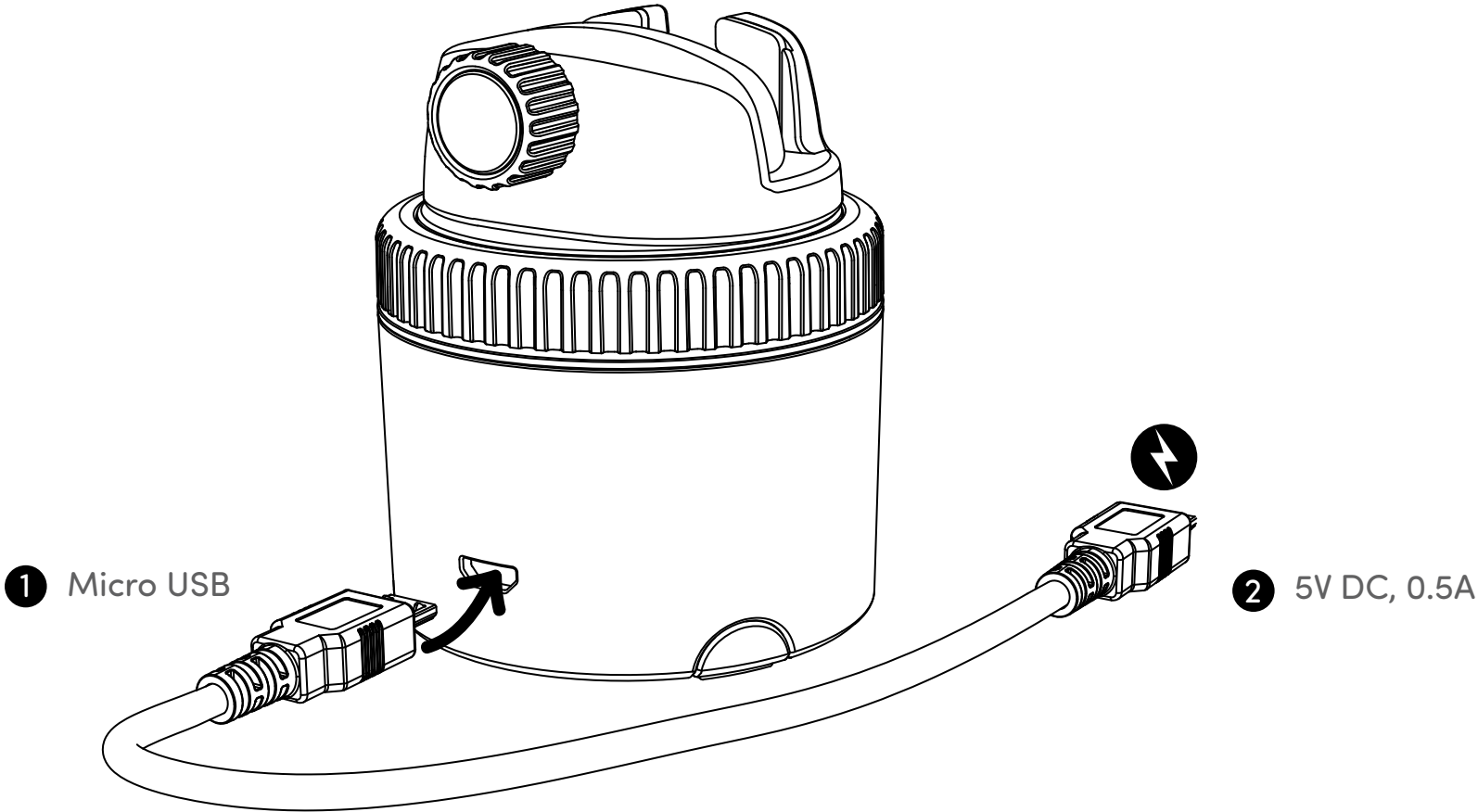

Weight: 6.2 oz / 176 g

Charging: Micro USB, 5VDC, 0.5A

Charging the Pod



LED indicator status

| | | |
|-------------------------------------|---|----------------|
| Power off |  | Blinking red |
| Power on / Ready for device pairing |  | Blinking blue |
| Connected to smartphone |  | Blue |
| Charging |  | Red |
| Fully charged | | No light |
| Low battery / Not charged |  | Blinking red |
| Pairing Remote Control |  | Blinking white |

Downloading the Pivo apps

Scan the QR code to
download the Pivo Pod App

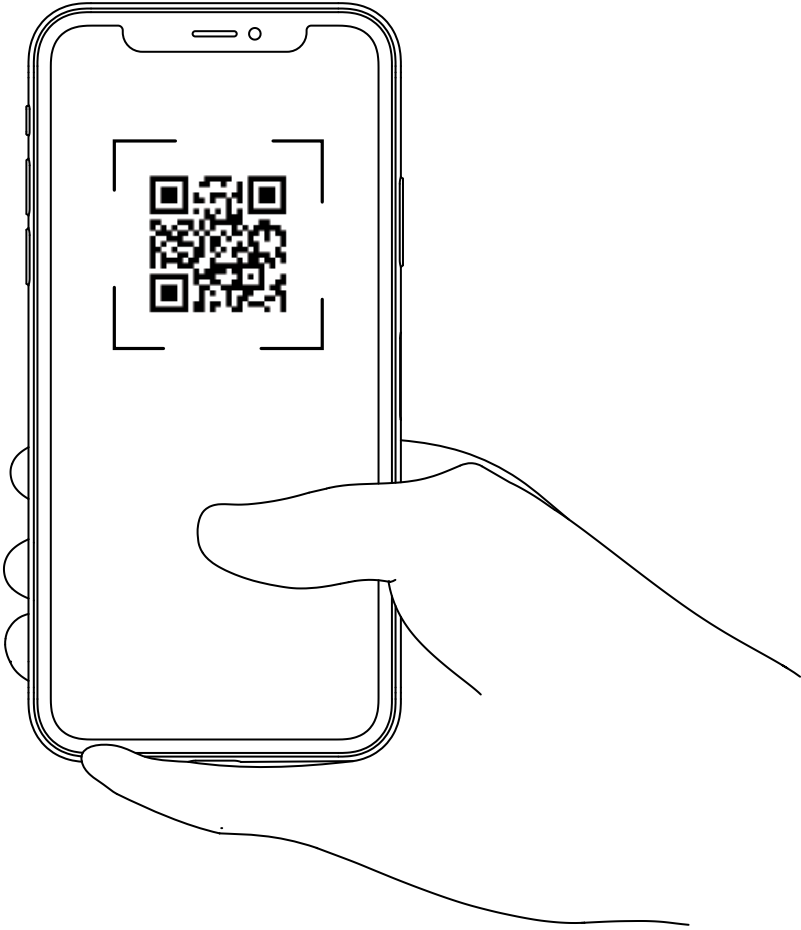

Creating a Pivo Account

1. Open the Pivo Pod App and tap **“Yes, I have Pivo”**
2. Log in using Facebook/Google Account or create a Pivo Account using a valid email address
3. To create an account please:
 - Tap **“Create account”** under the “Log in” button
 - Fill out the **“Sign up”** form
 - Confirm your registration by email
4. Go back to the app and “Log in” to your new account
Tap “Allow” to enable access to the microphone, photo album and voice recognition
5. Once you create a Pivo Account, your ID and password will be the same for all Pivo apps.

Pairing your smartphone

1. Turn your smartphone on and **enable Bluetooth**
2. **Press and hold the power button** until it beeps
3. In the app, tap **“Connect”** and follow the instructions on the screen to finish the pairing process

1



2

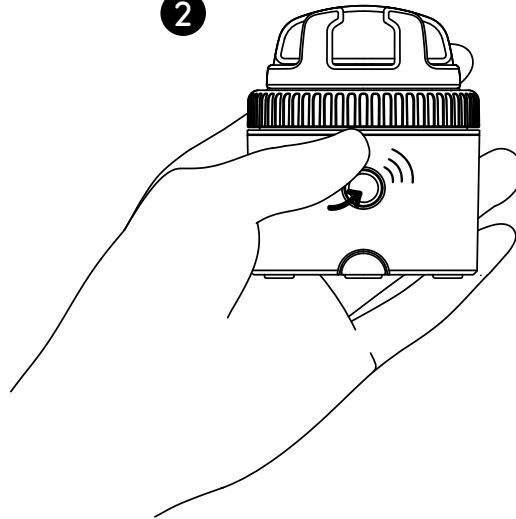

3

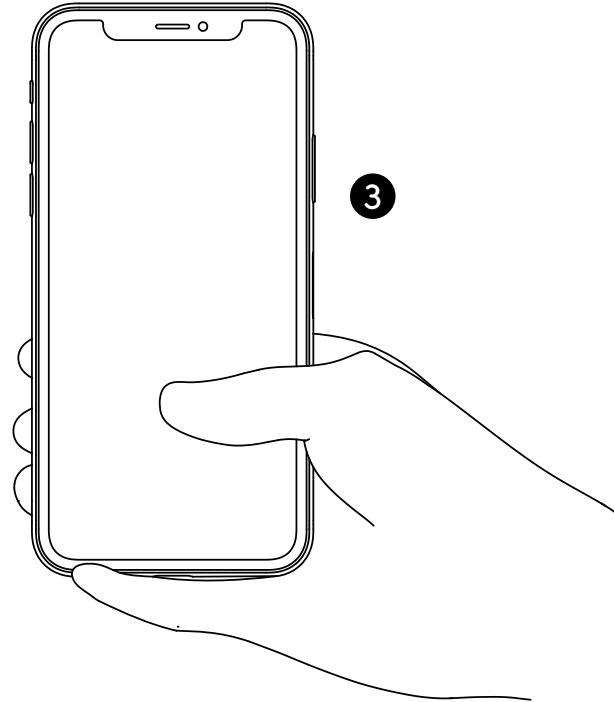

Positioning your smartphone

1. Place your smartphone onto the Panoramic Mount
2. Tighten the grip fastener to secure your smartphone

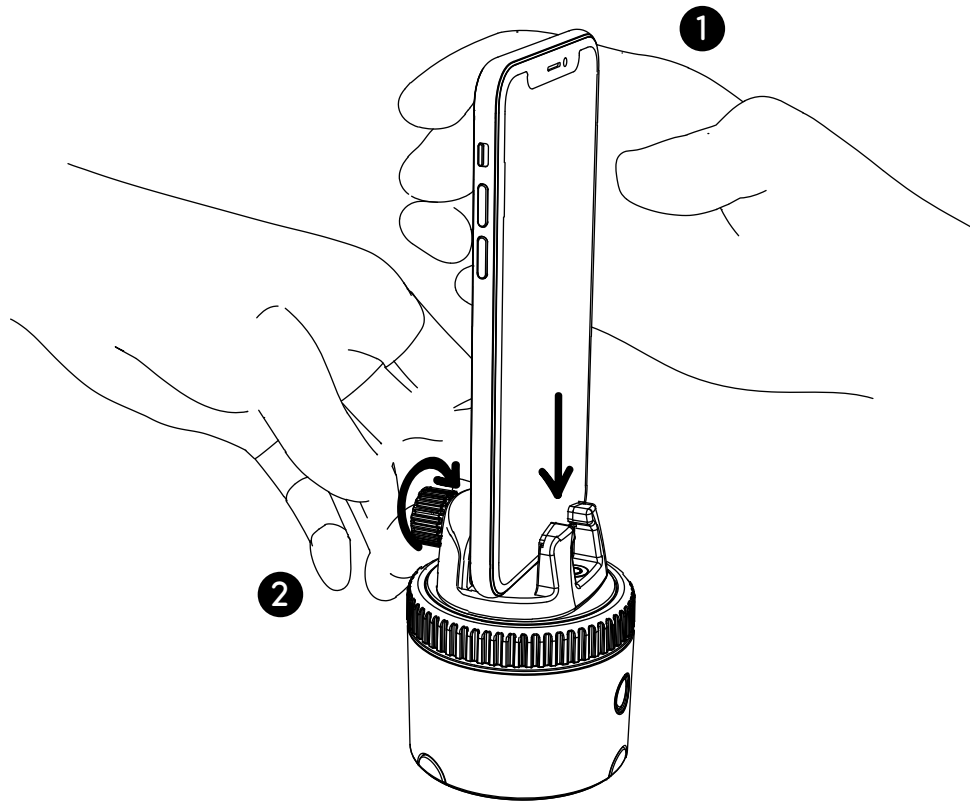

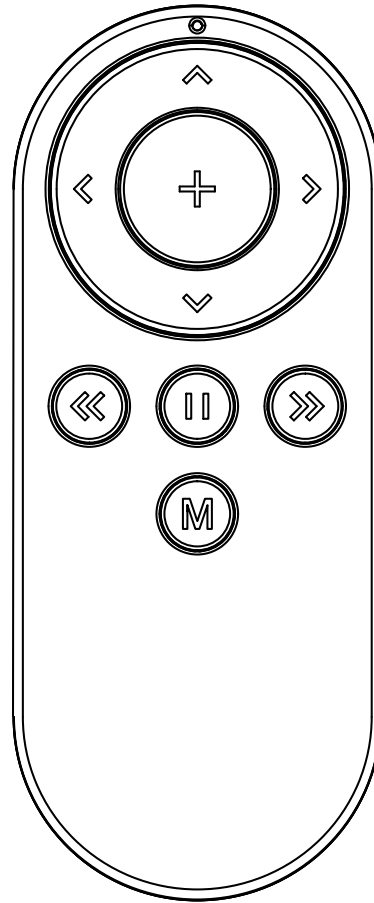







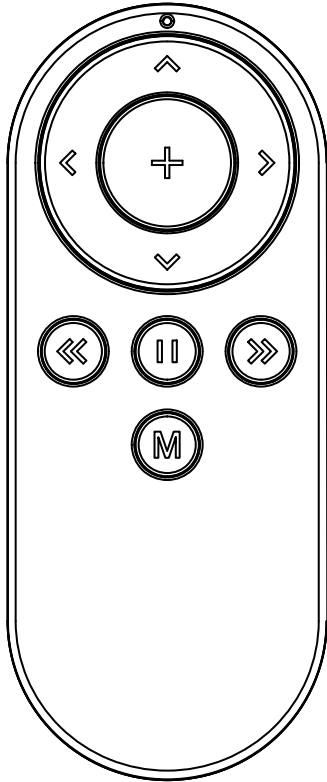



Pivo Remote Control

Quick start guide

Remote Control overview



-  Capture photo / Start recording
-  Increase speed
-  Decrease speed
-  Rotate clockwise
-  Rotate counterclockwise
-  Rotate clockwise 1 round
-  Rotate counterclockwise 1 round
-  Stop rotating / Cancel shooting (may vary depending on the mode)
-  Toggle between photo / video mode (may vary depending on the mode)

* For detailed information on how to use the Remote Control for each mode, visit help.getpivo.com

Replacing the Remote Control batteries

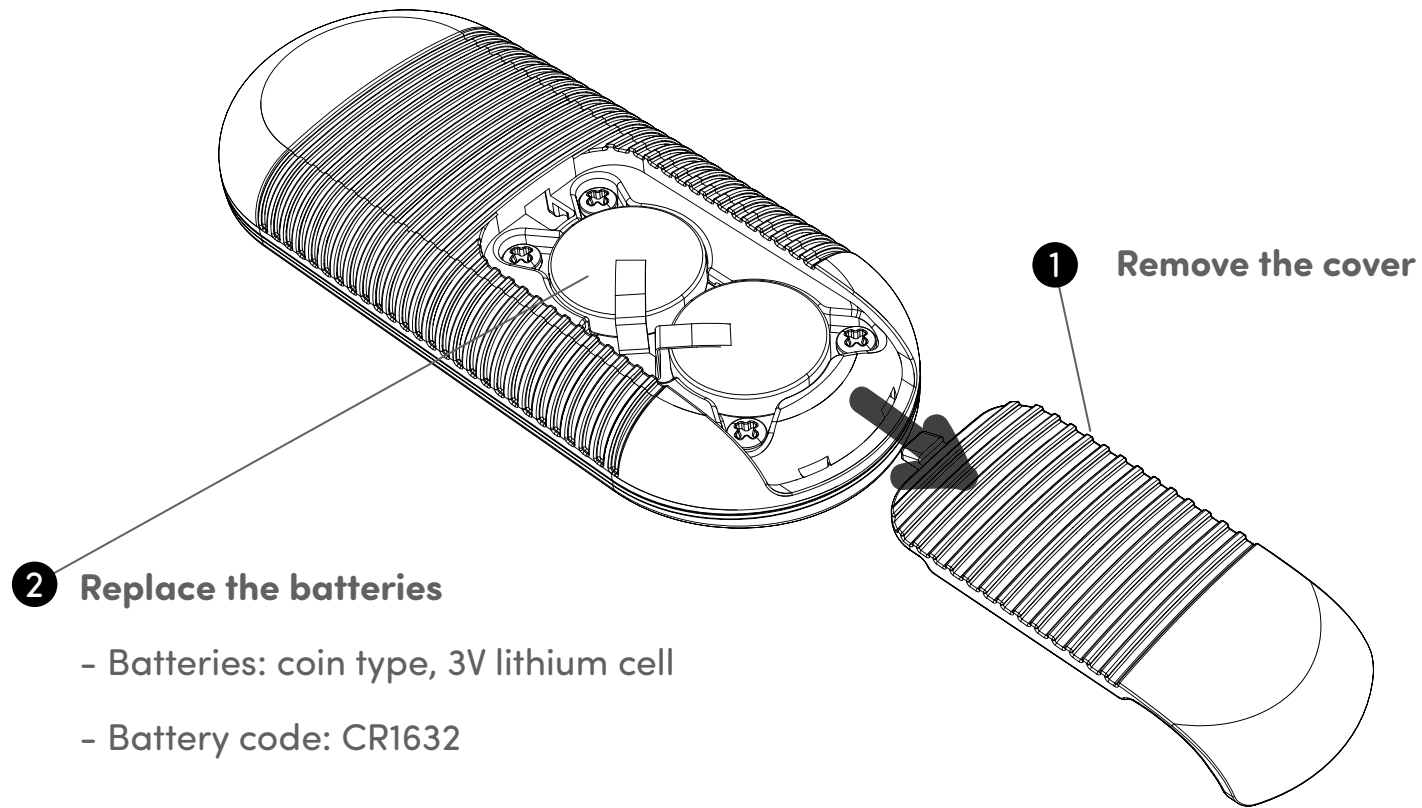

Pairing the Remote Control

The Remote Control comes already paired and ready to use. However, if the Remote Control becomes disconnected or if the batteries are replaced, the Remote Control needs to be paired as follows:

- 1. Press the power button 3 times in quick succession.** The LED indicator will turn white, indicating the Pivo Pod is ready to be paired with the Remote Control.
- 2. Press and hold the “+” button** on the Remote Control until you hear 3 quick beeps. This sound indicates that pairing is complete.

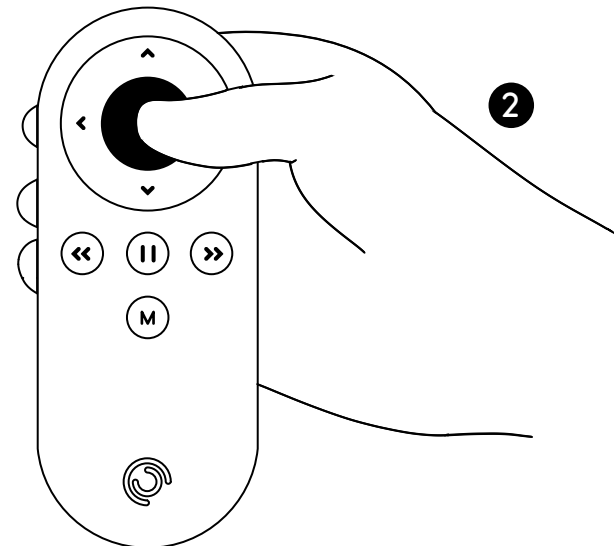
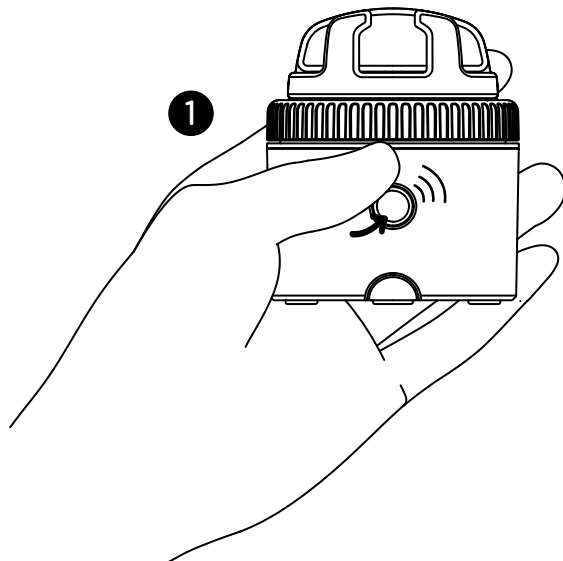

Remote Control settings

With your Remote Control, you can operate various core settings of your Pod including: rotation speed, rotation direction, shooting mode, shutter button & more.

- Up to 50 ft / 15 m operating range
- Can be paired with any Pivo Pod
- Comes with 2 replaceable 3V battery (coin type)
- For video instructions visit the official Pivo YouTube channel www.youtube.com/getpivo
- For a downloadable version of this manual, visit help.getpivo.com

Notice

[For Australian customers]

Our goods come with guarantees that cannot be excluded under the ACL. You are entitled to a replacement or refund for a major failure and for compensation for any other reasonably foreseeable loss or damage.

You are also entitled to have the goods repaired or replaced if goods fail to be of acceptable quality and the failure does not amount to a major failure.

If you suspect your child has swallowed or inserted a button battery, **call** the Poisons **Information Centre** immediately on **13 11 26** for 24/7 fast, expert advice.
If your child is having any difficulty breathing, **contact 000**.



FCC Compliance

This equipment has been tested and found to comply with the limits for a Class B digital device, pursuant to part 15 of the FCC Rules. These limits are designed to provide reasonable protection against harmful interference in a residential installation. This equipment generates, uses and can radiate radio frequency energy and, if not installed and used in accordance with the instructions, may cause harmful interference to radio communications. However, there is no guarantee that interference will not occur in a particular installation. If this equipment does cause harmful interference to radio or television reception, which can be determined by turning the equipment off and on, the user is encouraged to try to correct the interference by one or more of the following measures:

- Reorient or relocate the receiving antenna.
- Increase the separation between the equipment and receiver.
- Connect the equipment into an outlet on a circuit different from that to which the receiver is connected.
- Consult the dealer or an experienced radio/TV technician for help.

EU Compliance

This product complies with Directives **2014/53/EU** and **2014/30/EU, 2014/35/EU**.

Information on conformity can be found at the following website:

<https://help.getpivo.com/hc/en-001/categories/360006173271-Warranty>

Introducing Pivo apps



Pivo Tour



Pivo Present



Pivo Meet



Pivo Pod App



Pivo Tour

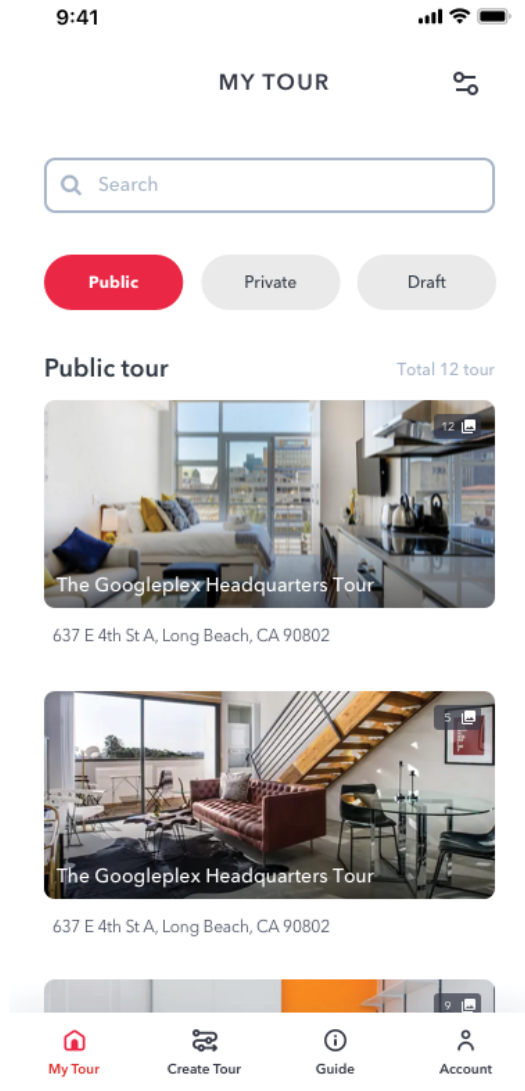

Create immersive and high-quality virtual tours right from your smartphone.

For the best results, Pivo Pod Black should be used with a Tripod to capture unimpaired, all-inclusive virtual tours.

Customize your tour, then share it with a URL or embed it on your website.

Scan the QR code to download.



Getting started

1. Secure your Pivo Pod Black on the Tripod
2. Mount your smartphone in portrait mode and fasten the grip to secure
3. Use the Remote Control **“+” button** to capture each scene
4. For more information on how to use Pivo Tour, visit our Support Hub at help.getpivo.com

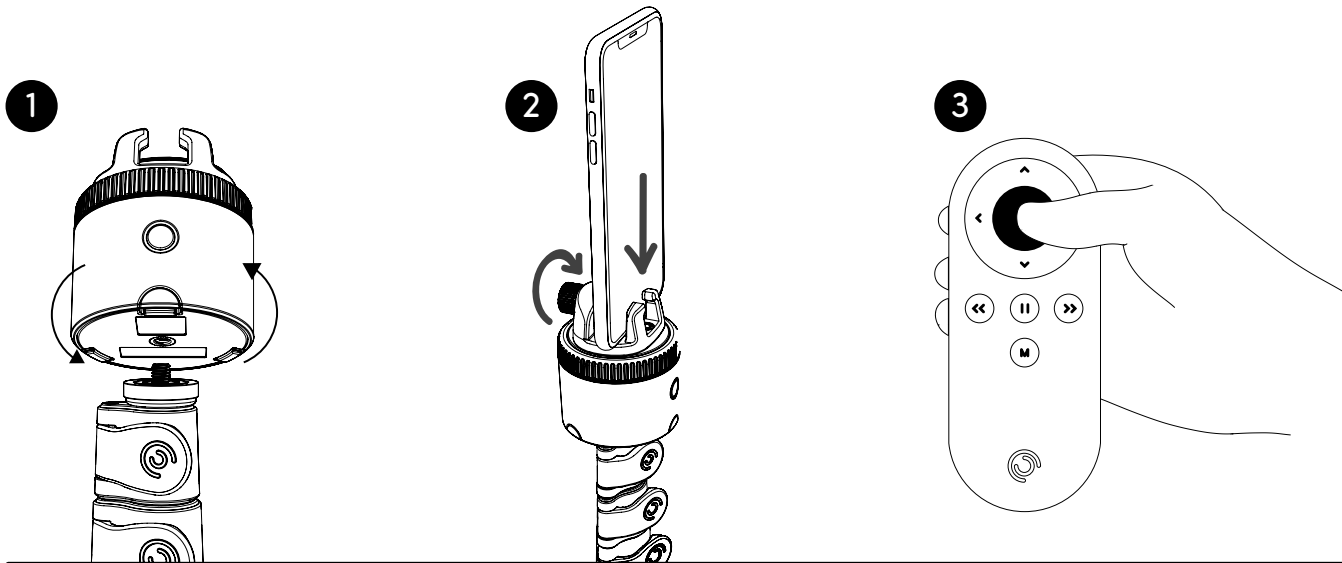

Pivo Present

Bring Auto Tracking to your presentations to boost engagement.

Record and share your presentations in Google Chrome.

Use Auto Tracking during the presentation (Face, Body, Action).

Use the Remote Control to record, switch modes, and change slides.

Scan the QR code to download.



Getting started

1. Download and launch the Pivo Present Chrome extension

- Go to the Chrome web store and search for **“Pivo Present”**
- Download and launch the extension in your Chrome browser

2. Download and launch the Pivo Present app

- From your smartphone, download **“Pivo Present”** from the App Store (iOS) or Google Play Store (Android)
- Launch the Pivo Present app

3. Sign in with your Pivo Account







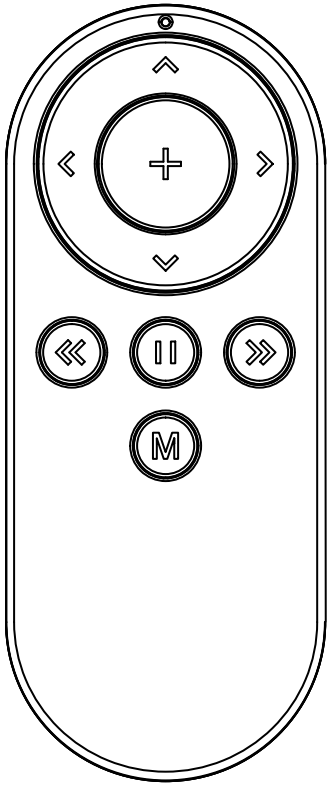

Start presenting

1. Launch the Pivo Present Chrome extension from your laptop / PC
2. Open the Pivo Present app from your smartphone and connect to Pivo Pod Black
3. Scan the QR code from the Chrome extension to connect your smartphone with the laptop / PC
4. Click **“Start Presenting”** from the Chrome extension



Using the Remote Control while presenting



-  Switch mode
-  Pause/Resume recording
-  Zoom in
-  Zoom out
-  Previous slide
-  Next slide
-  Tracking on/off
-  Manually rotate the Pod
-  Manually rotate the Pod

Pivo Meet

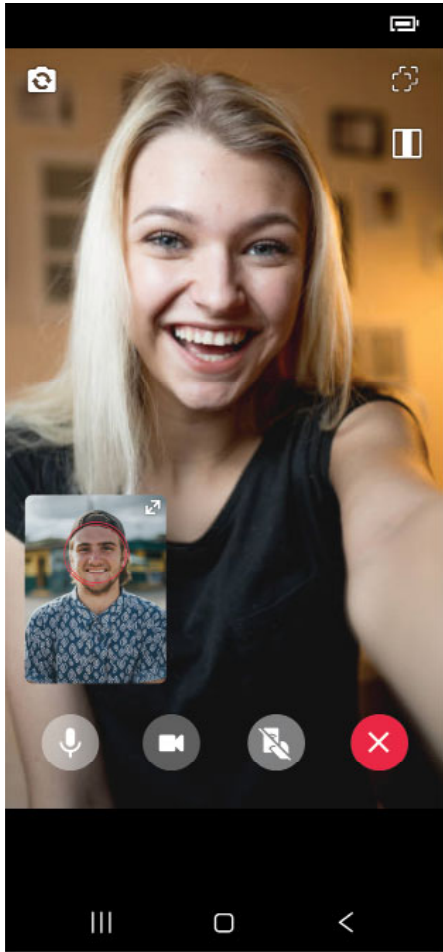

Video call hands free with anyone, anywhere and have Pivo track you at the same time!

Four different tracking modes (Face, Body, Horse, Action).

Easily invite your guest with a link.

Scan the QR code to download.



Inviting someone to Pivo Meet call

1. Make sure that Bluetooth is turned on and you have a WiFi connection
2. Open the Pivo Meet app
3. Sign into Pivo Meet using your Pivo Account (see page 8)
4. Copy the link on the screen
5. Share the link on any platform (social media, email, etc.) to the person you want to invite
6. Press the **“Start Meet”** button to start the call

Accepting a Pivo Meet call invitation

1. Open the notification with the Pivo Meet invitation link attached
2. Allow Pivo Meet to use your camera and microphone

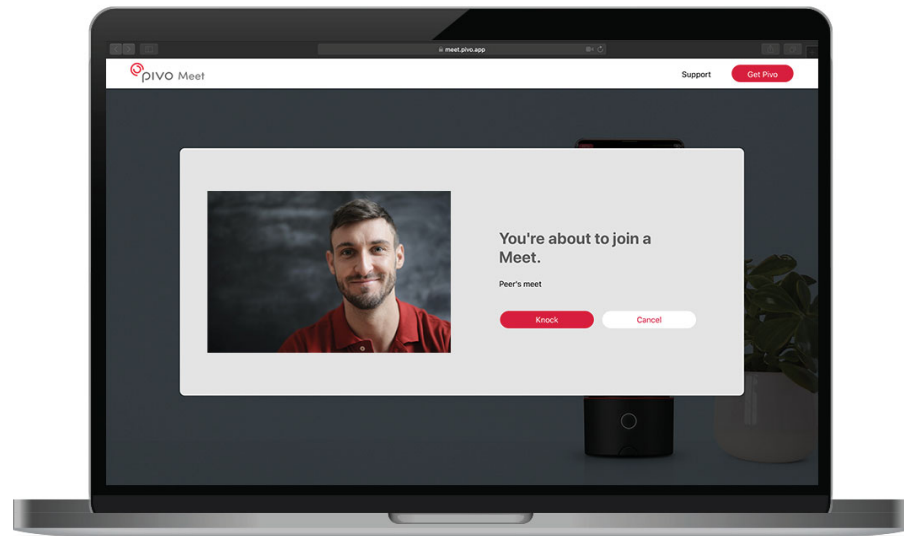

Disclosure

Pivo Meet is designed to be **used ONLY** in the following situations:

- The caller must have a Pod and Pivo Account to sign into Pivo Meet
- The receiver can answer the call request with a smartphone, computer or tablet

* **The person who received the link from the caller cannot receive it with a Pivo.**

The link will open in a web browser, and is accessible via their smartphone, computer or tablet, as long as they have video calling capabilities.

Pivo Pod App



Create awesome content with Pivo's Auto Tracking, Smart Capture modes and Quick Create modes.

Easily take photos and videos by yourself, handsfree.

- Smart Capture modes (Voice, Gesture, Pose, Action)
- Four different tracking modes (Face, Body, Horse, Action)
- Multistream Live

Scan the QR code to download.



Getting started

1. Make sure that Bluetooth is turned on and you have a WiFi connection
2. Open the Pivo Pod App
3. Pair Pod Black with your smartphone

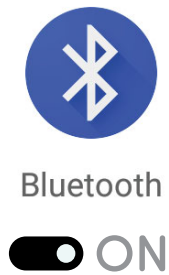

Additional information

For video tutorials, visit our official YouTube channel [youtube.com/getpivo](https://www.youtube.com/getpivo)

For your country's warranty please visit our website on help.getpivo.com

Need more information? Scan the QR code below or visit our Support Hub help.getpivo.com



2019 Pivo Inc. All rights reserved.
3003 North 1st Street San Jose, California CA 95134
support@getpivo.com
www.getpivo.com
Social media @getpivo



KC : R-C-3AI-PIVO-R1
FCC ID : 2AS3Q-PIVO-R1
TELEC : 210-125414
NCC : CCAM21LP1140T8